



## Pet Containment System Manual

Compatible with Auto Lawn Mowers



# Contents

What's in the Box. . . . .	3
<b>How to Set Up Your System</b>	
Step 1: Locate the Stayfence transmitter. . . . .	4
Step 2: Choosing a layout . . . . .	4
Step 3: Installing the Stayfence boundary wire . . . . .	8
Step 4: Prepare the Stayfence receiver collar . . . . .	10
Step 5: Connecting the boundary wire to the Stayfence transmitter . . . . .	13
Step 6: Setting the warning & correction zones on your transmitter . . . . .	14
Step 7: Repairing and adding additional wire . . . . .	16
Step 8: To check that your Stayfence system is setup and working . . . . .	17
Step 9: Fit the Stayfence receiver collar . . . . .	19
Training your pet. . . . .	20
Taking your pet out of the containment area. . . . .	21
Troubleshooting. . . . .	22
Short loop test. . . . .	25
Locating a break in the boundary wire. . . . .	26
Product Information . . . . .	27
Replacement parts available. . . . .	28



## What's in the Box

**1 x 200M roll of wire (656.16 ft)**

**2 x gel filled wire joiners**

**1 x magnet used to change the correction level on receiver**

**1 x Transmitter**

**1 x Power transformer**

**1 x bundle of flags (50pcs)**

**1 x Receiver collar**

**1 x Test bulb**

**1 x Instruction Manual**

# How to set up your system

## Step1: Locate the Stayfence transmitter

The Stayfence Transmitter should be installed:

- In a dry, well ventilated, protected area.
- In an area where temperatures do not fall below freezing that is a moisture free environment.

***Note: The Stayfence transmitter unit is not suitable to be located outdoors.***

- The Stayfence transmitter can be wall mounted or placed on a flat surface. Most importantly, it should be located in an area out of reach of children.
- It is also advised not to locate the Stayfence transmitter near large metal objects, for example refrigerators, and heating systems.
- Once the Stayfence Transmitter is installed, the Stayfence Boundary wire can exit the building via a window or through a drilled hole in the wall. Care has to be taken that the wire is not damaged or pinched by a window, door, or garage door.
- The Stayfence transmitter must be plugged into an approved electrical supply.

## Step 2: Choosing a layout

**Choose the best suited layout for your property and lay out the Stayfence boundary wire. Check that the system is working correctly, BEFORE burying the wire or attaching it to an existing fence. Treat the wire carefully as even small damages can diminish the signal strength and create a weak area where your pet can escape.**

Running the Stayfence boundary wire parallel to and within 2 meters (6.6ft) of electrical wires, neighbouring containment systems, telephone wires, television or antenna cables, or satellite dishes may cause an inconsistent signal.

- At all times, the boundary wire must complete a full loop by starting and ending at the fence transmitter **(2A).page 6**
  - Design a layout that is suitable for your garden.
  - At corners, use gradual turns instead of sharp turns which may cause disruption of the signal **(2A).page 6**
  - With a double loop layout, ensure that the wires are at least 1.5m (5 ft apart), **(2D).page 6**
- Avoid creating areas that are too narrow for your pet to move about freely.
- It is possible that the Stayfence receiver collar may be activated inside the house if the boundary wire runs along the outside wall of the house. In this case, remove your pet's Stayfence receiver collar before bringing him inside and decrease the range using the boundary or consider an alternative layout.

### Twisting the Stayfence Boundary Wire

In order to create an area where it is safe for your pet to cross over, you have to twist the wire. **Note:** this is only possible emerging from the Stayfence.

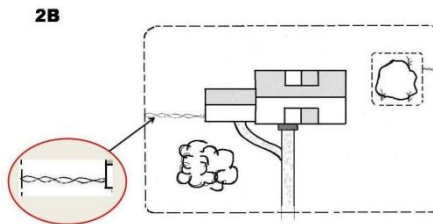

transmitter box running to the boundary wire or when creating a separate boundary around a small area, for example a vegetable patch or a pond **(2B)**. You cannot twist the wire along the main boundary wire.

## Sample Layouts

### Normal Layout

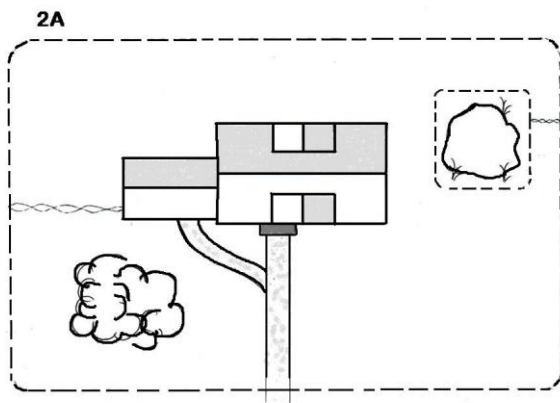

### Double Loop Layout

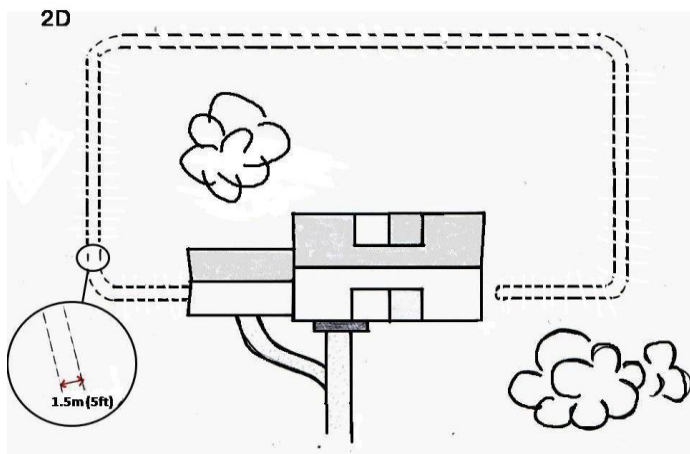

**Boundary Wire at Existing Fence**

2C

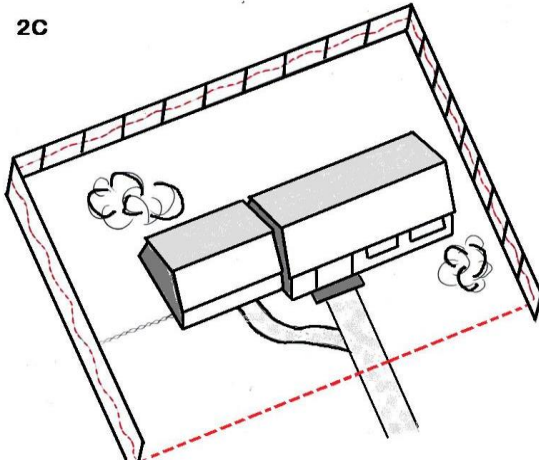

**Front Boundary with Double Loop**

2E

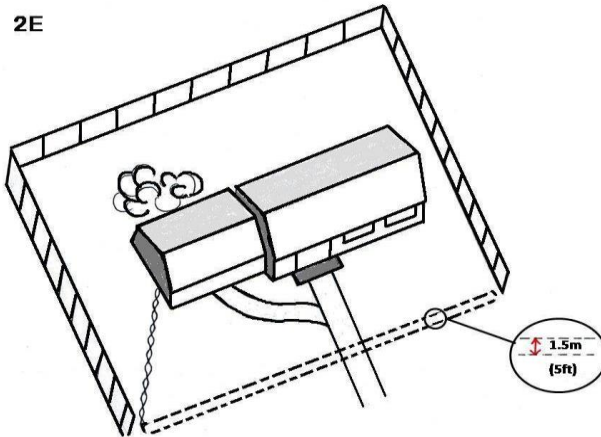

## Step 3: Installing the Stayfence Boundary Wire

The Stayfence boundary wire can be buried up to 5cm (2 inches) below ground. Or can be as high as 1m (3ft) over ground.

### Basic Planning Tips:

**Warning:** When deciding to bury the boundary wire, care has to be taken that digging does not interfere with other buried power, telephone, or electrical cables in the vicinity. Many underground cables carry high voltage and digging into them, or laying your boundary wire on them, may lead to hazard from shock or electrocution. It is advised to consult with the local utility company regarding the location of underground lines.

### **To Bury the Stayfence Boundary Wire**

Burying the boundary wire will help to protect it from possible damage that could distort the radio signal.

1. Break the ground with the edge of a spade to bury the wire.
2. Place the boundary wire around 5cm (2 inches) deep into the broken ground, using a blunt tool such as a wooden paint stick to prevent possible damage to the boundary wires insulation coating. Leave some slack to allow for possible expansion and contraction with temperature variations.



## To Attach the Stayfence Boundary Wire to an Existing Fence

The boundary wire can be attached to a chain link fence or wooden fences. When attaching the wire to the fence, ensure that the boundary width is set at a high enough range for the pet to receive the signal. If using a double loop with an existing fence at least three feet tall, run the boundary wire on top of the fence and return it on the bottom of the fence to obtain the required separation of 1 to 2 meters (3 to 6ft).

- **Chain Link Fence:** Weave boundary wire through the links or use plastic quick ties.

- **Wooden Split Rail or Privacy Fence:** Staples can be used to attach the boundary wire, nevertheless, be careful not to puncture the insulation of the boundary wire.

- **Double Loop with an Existing Fence:** Run the boundary wire on top of the fence and return it on the bottom of the fence to get the three to five foot separation needed.

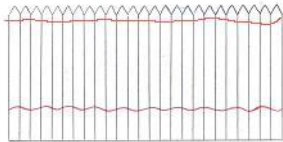
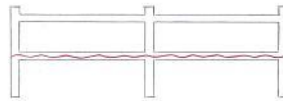
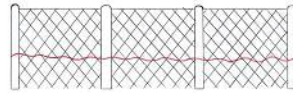

- **Gate (Single Loop):** The boundary wire should be buried in the ground across the gate opening. **Note: The signal is still active across the gate. Your pet cannot pass through an open gate.**

## To Cross Hard Surfaces (driveways, footpaths, etc.)

- **Concrete Driveway or Footpath:** Use an expansion joint or create a groove using a circular saw and masonry blade to place the boundary wire in. When placed in the groove, the boundary wire should be covered with an appropriate waterproofing compound.

- **Gravel or Dirt Driveway:**

For protection, the boundary wire can be placed in a PVC pipe or water hose before burying.

## Step 4: Prepare the Stayfence Receiver collar

Your Stayfence receiver collar comes with short contact points for very short haired pets and long contact points for pets with medium & long or thick hair pets.

Tighten the contact points one half turn beyond finger tight. Check the tightness weekly.



### To Insert and Remove the Battery

The collar uses a simple 3 volt cr-2 battery. To purchase individual batteries please refer to our website. [www.stayfence.ie](http://www.stayfence.ie), or your point of purchase. To install the battery remove the circular silver cap using a coin. Insert the battery with the + (positive) side facing upwards towards the silver cap which the then screw back into position, as in picture below.

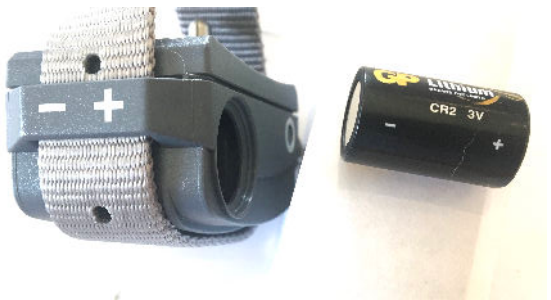
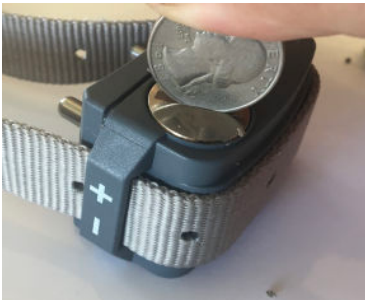

**The estimated life expectancy of the battery is between 4 to 6 months.**

### **Battery Check Tip:**

Check the battery every week to ensure the collar is working, if you need to change battery, purchase and use a 3 volt cr-2 battery.

### **Setting the static correction level**

The Stayfence receiver collar(s) have 3 output levels of strength.

1. With the battery installed, place the supplied magnet to the dimple
2. Hold the magnet as seen in the image below, you will hear the receiver collar beep once, then twice, then a third time, (one higher each beep). Take the magnet away from the dimple to settle on the correction level you require for your dog as per table (**page 12**).



The static correction levels increase in strength from 1 to 3. Placing the magnet to the small circular dimple (on the same side to where you inserted the battery) the Stayfence receiver collar will beep to indicate a level change. Refer to the table that follows to choose the static correction level that best fits your pet.

The Stayfence receiver collar is equipped to automatically increase the level of static correction the longer your pet remains in the static correction zone.

<b>Indicator Beep</b>	<b>Static Correction Level</b>	<b>Receiver Collar Function</b>	<b>Temperament of Pet</b>
<b>1 Beep</b>	1	Low Static Correction	Placid
<b>2 Beep</b>	2	Medium Static Correction	Timid
<b>3 Beep</b>	3	High Static Correction	High Energy
<b>KEEP</b>			
<b>USEFUL</b>			
<b>NOTES</b>			
<b>HERE</b>			

## Step 5: Connecting the Stayfence Boundary Wire to the Stayfence transmitter.

1. Strip the ends of the boundary wire approximately 10mm.
2. Identify the large green 2 holed block connector. (Picture a)
3. Gently remove this block from the transmitter. (Picture b)
4. Insert one wire end into each hole and use a small screwdriver to tighten the wire into the connector block. (Picture c)
5. Once that is done check that the wires cannot come back out. (Picture d)
6. Finally when done reinsert the connector block back into the original position in the transmitter. (Picture e)

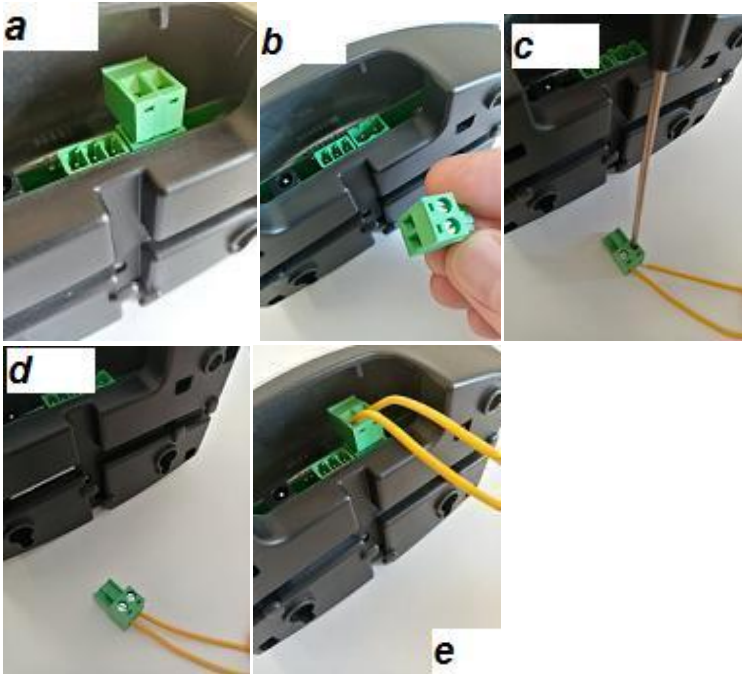

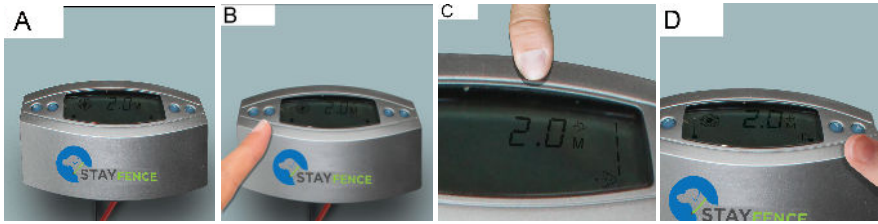

## Step 6: Set up the warning and correction zones on your transmitter:

After planning and laying out your boundary wire, the stripped back wire ends must be inserted into the transmitter (see page 18/19), before setting your zones.

Plug the transmitter in an electrical point and press the power button to POWER ON your transmitter, the LCD screen display will then be visible (Picture **A**) above.

Then press the “P” button (Picture **B**) above, and note the symbol in the top right corner of the LCD screen. You will need the symbol that shows the little arrow pointing away to the left (Picture **C**) above, the warning zone symbol (it will also have the letter M under it).

Once you have selected the warning zone symbol use the down/up buttons to set the warning zone (Picture **D**) above. We recommend selecting a warning zone of 2.0m (6ft). You may choose different settings if you wish.

Next you must set the correction zone.

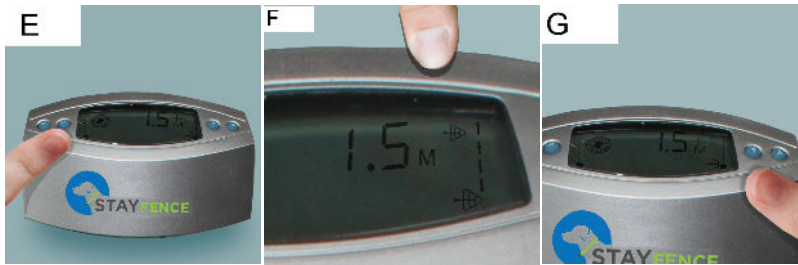

Well done you have reached the next step. The [warning zone](#) has been set, now set the [correction zone](#).

Press the “p” button (Picture E) again and note that the symbol in the top right corner of the LCD screen will now change from the warning zone symbol to the [correction zone](#) symbol, it will have the zig /zag line in it and will be above the letter M slightly to the right (Picture F).

Once you have selected the correction zone symbol use the down/up buttons to set the correction zone (Picture G).

We recommend selecting a correction zone of 1.5m (5ft).

You may choose different settings if you wish.

The two zones on your transmitter have now been set.

## Step 7: Repairing and adding additional wire

### To Splice or Repair the Stayfence Boundary Wire

•When expanding or repairing the existing boundary wire, the wires have to be spliced together.

**Note: Remember the locations of all splices for future reference as they are often the place where the wire breaks in the future.**

•Insert the ends of the wire into the wire connector (3A,1).

•Use pliers to push down the round, RAISED (marked in orange) part on the wire connector as far as possible (3A, 2).

### 3A

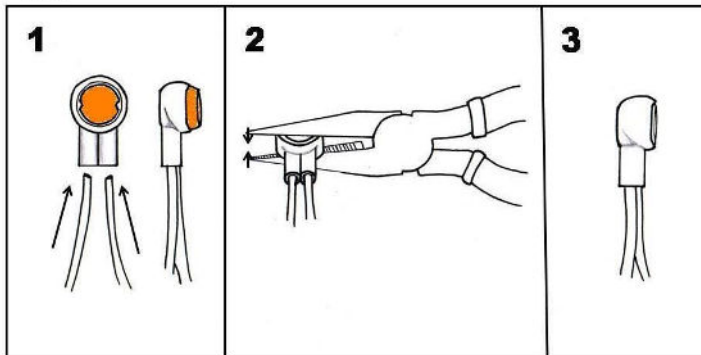

**Gel  
Joiner**



**Note: Pliers should be used to push down fully the RAISED part of the wire connectors to ensure that the wire insulation is pierced so the radio signal can run through the connector.**

•Gel inside the connector is released which insulates it and makes it waterproof. Ensure that the splice is not loose as this will result in a failure of the system. The connector is suitable for underground and above ground use ( For additional gel-filled wire connectors ) please refer to our website. [www.stayfence.ie](http://www.stayfence.ie)



## Step 8: To check that your Stayfence system is setup and working.

Our Stayfence containment systems use an AUTOTUNE technology. This new technology is exclusive to Stayfence products. It allows the Stayfence transmitter to automatically detect the length of wire used to surround your garden.

**For the warning and correction zones:** we would recommend setting your transmitter settings as follows. Set your warning distance zone to 2m (6ft) and your correction zone to 1.5m (5ft).

**For the receiver collar:** We would recommend setting your receiver to the lowest level (1 beep), as the collar has progressive correction levels, should your dog not react to the set level, the levels will increase automatically, once the dog retreats back into the safe zone the receiver collar will then revert back to the set level.

***Note: Only use the Test Light to test your receiver collar, never use any other metal object.***

***And remember to remove the Test Light before putting the receiver collar back on your dog, as not doing so will cancel the correction when the receiver is put back on your dog.***

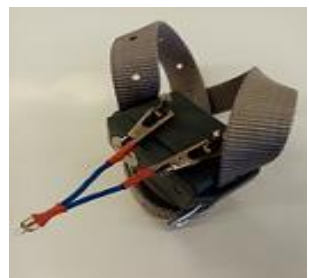

Make sure the Stayfence receiver collar battery is properly installed and the static correction is set level 1

- For best results, select a section of straight Boundary Wire.
- Connect your test bulb clips to each contact point (Pg 17).
- Walk towards the boundary wire with contact points pointing up and holding the Stayfence receiver collar at your pet's neck level until the receiver collar beeps and the test light flashes.

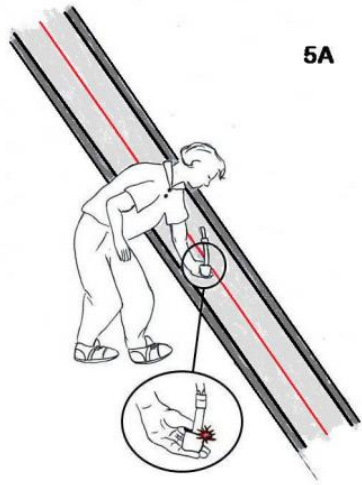

- After hearing the beep, continue to walk towards the wire.

The Stayfence receiver collar should tick and the test light should flash, indicating the static correction as you enter the static correction zone. A warning tone and the flashing of the test light indicate that the Stayfence receiver collar and the system are working properly. To ensure the system is working correctly, test in a number of different areas around your property.

**Note: The Stayfence Receiver Collar is waterproof, which can make the beep hard to hear.**

With a double loop layout, you may need to increase the separation of the boundary wire to achieve desired range.

**Test Bulb & Magnet Storage Tip.** When you are finished using the test bulb and magnet, why not attach them to one of the boundary wires at the base of your transmitter. This will help you to keep them at hand for the next time you will need them. (Picture A1, Page 17)

## Step 9: Fit the Stayfence Receiver Collar

**Important:** The proper fit and placement of your Stayfence receiver collar is important for effective training. The contact points must have direct contact with your pet's skin on the underside of his neck.



To fit the collar correctly, place the receiver collar around your dog's neck **WITHOUT** the battery in it.

**Note:** *It is sometimes necessary to trim the hair around the Contact Points to make sure that contact is consistent.*

### **Check the tightness of the Stayfence receiver collar:**

1. The aim is be able to get the top of your index finger between the tip of the contact point and your dog's neck with little difficulty, if you can't, it's too tight and if you can pass your finger over without any difficulty it's too loose.
2. Once satisfied with the fit of the receiver collar, trim any excess nylon strapping, sealing the cut edge with a small flame. Also allow for your pets growth and thick winter coat.

## Training the Your Pet

**Step 1:** Before you can start the training, the Stayfence training flags have to be set up. Place individual training flags into the ground along the line where your dog's collar emits the audio warning signal. The flags should be placed at approximately 4 to 5 meters (12 to 15 feet apart)

### **Set up:**

The Stayfence boundary flags are visual reminders for your pet of where the warning zone is located.

1. Place the test light contacts on the contact points and hold the Stayfence receiver collar at your pet's neck height.
2. Walk towards the warning zone until the Stayfence receiver collar beeps.
3. Place a Stayfence boundary flag in the ground.
4. Walk back into the containment area until the beeping stops.
5. Repeat this process around the warning zone until it is marked with boundary flags every 4 to 5 meters (12 to 15ft).

**Please note:** To place the flags, do not walk in a parallel line along the boundary where the warning signal is audible. Instead, you must walk up to the boundary, when you hear the warning signal place the flag and then step away again (6A) next page. Repeat this process for each flag. Otherwise, the collar may disengage/ time out and no warning signal can be heard.

**Step 2:** Approach your dog and put on his Stayfence collar. At the beginning of the training set the correction level guide (**page 12**). Attach a lead to his usual walking collar and slowly walk the dog towards the flag. Once you reach the flag the dog will hear an audio beep. At that point while still on the leash, walk him back immediately. If you do not move back your dog will receive a static correction to discourage him from lingering along the boundary line.

**Please note:** Do not bring the dog across the boundary wire as he may associate you with the static correction. **Step 3:** Continue this process for the next few days.

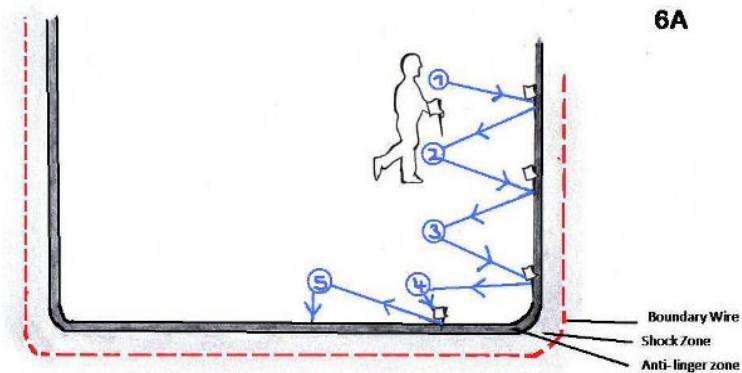

## Taking Your Pet Out of the Containment Area

1: The pet can be driven out of the containment area in a car, AFTER replacing the Stayfence® collar with a regular collar. During the first two weeks of training, it is advisable to only take your pet out of the property in a car. **REMEMBER** to take the Stayfence receiver collar off first.

2: Replace the Stayfence® receiver collar with a regular collar and leash. Walk your pet out of the containment area while giving a command such as “OK” at a specific place in the boundary zone (such as a gateway). Always leave the containment area with your pet on a leash at this same place. Your pet will associate safely leaving the containment area, only on a leash, only at this place, and only with a person. You may initially need to convince your pet to leave the pet area with a food treat and lots of praise.

**Note:** Again do not start to teach your pet to walk out of the area for at least 2 weeks so as not to confuse.

<b>Troubleshooting</b>	
<b>Stayfence Receiver Collar is not beeping or correcting.</b>	<ul style="list-style-type: none"> <li>• Check battery to make sure it is installed properly.</li> <li>• Check that both the loop indicator light and the power light are lit on the Stayfence Transmitter. If not, perform the “Short Loop Test”(page25)</li> </ul>
<b>The Stayfence Receiver Collar is beeping, but the pet is not responding to the Static Correction.</b>	<ul style="list-style-type: none"> <li>• Change to long contact points.</li> <li>• Test the Stayfence receiver collar with the test light walking toward the boundary wire.</li> <li>• If the test light flashes, Check <b>Step 9</b> on <b>(Page 19)</b>.</li> <li>• Check the correction level (page 12).</li> <li>• Purchase a stronger Stayfence receiver Collar.</li> </ul>
<b>The Stayfence Receiver Collar has to be close to the boundary wire to activate.</b>	<ul style="list-style-type: none"> <li>• Replace battery.</li> <li>• Adjust upwards the warning zone distance.</li> <li>• If using a double loop, make sure boundary wires are separated 1 to 1.5m/ 3 to 5ft.</li> <li>• Check splices for possible corrosion or damage</li> </ul>

<p><b>The Stayfence Receiver Collar activates inside the house.</b></p>	<ul style="list-style-type: none"> <li>• Decrease the warning zone distance.</li> <li>• Make sure the Stayfence boundary wire is not running too close to the house. The signal can transmit through the walls of your house. In this case you may have to change your layout.</li> <li>• Check splices for possible corrosion.</li> <li>• Make sure the Stayfence boundary wire is twisted from boundary to the fence transmitter.</li> </ul>
<p><b>I have an inconsistent signal.</b></p>	<ul style="list-style-type: none"> <li>• Make sure the Stayfence transmitter is at least 1m/3 feet from large metal objects or appliances.</li> <li>• Make sure all boundary wire turns are gradual.</li> <li>• Make sure the Stayfence boundary wire is not running parallel to and within 1.5m/5 feet of electrical wires, neighbouring containment systems, telephone wires, television or antenna cables.</li> <li>• Check splices for possible corrosion and check for damages in the wire insulation.</li> <li>• If a neighbour has a containment fence It may be interfering with the signal</li> </ul>
<p><b>The Power and Loop Indicator Lights are off.</b></p>	<ul style="list-style-type: none"> <li>• Check that the power adapter is plugged into the Stayfence transmitter.</li> <li>• Try plugging into another 240-volt outlet.</li> <li>• If the lights still do not come on, the Stayfence transmitter and/or power adapter needs to be replaced. Visit our website <a href="http://www.stayfence.ie">www.stayfence.ie</a></li> </ul>

<p><b>The Power Light is on, the Loop Indicator Light is off, and the Fence Transmitter loop alarm is sounding</b></p>	<ul style="list-style-type: none"><li>• Make sure both ends of the Stayfence boundary wire are plugged into the loop wire inputs of the Stayfence transmitter and that 12mm or 1/2 inch of the insulation is stripped so that the copper wire is exposed.</li><li>• Perform the “Short Loop Test” (<b>page 25</b>) to determine if the Stayfence transmitter needs to be replaced or if the boundary wire is broken.</li><li>• If the Stayfence transmitter is functioning properly, you have a break in your boundary wire. See the “Locating a Break in the Wire” (<b>page 26</b>) section in this guide.</li></ul>
--	---



## Short Loop Test

The short loop test is a simple test to determine if each component (Stayfence Transmitter, Stayfence Receiver Collar and Stayfence Boundary Wire) is functioning properly.

1. Disconnect the Stayfence boundary wire from the transmitter.
2. Cut approximately 3 meters / (10ft) of unused boundary wire and connect it to the loop wire inputs.
3. Spread the boundary wire out into a circle.
4. Set the warning zone to 2m(6ft) and the static correction level, to level 2 or above.
5. If the loop indicator light is not lit, then your Stayfence transmitter is not functioning properly, contact [info@stayfence.ie](mailto:info@stayfence.ie)
6. If the loop indicator light is lit, disconnect one end of the boundary wire from the loop wire inputs.
7. If the loop alarm does not sound, the Stayfence transmitter needs to be replaced, contact [info@stayfence.ie](mailto:info@stayfence.ie)
8. If the loop alarm does sound, plug the boundary wire back into the loop wire inputs.
9. Connect the test light to the Stayfence receiver contact points. Hold the Stayfence receiver collar next to the 3m/10-ft length of boundary wire. The Stayfence receiver collar should beep about 300mm/1ft away from the boundary wire. The test light should then flash as you hold the Stayfence receiver collar closer to the boundary wire.
10. If the Stayfence receiver collar does not beep and the test light does not flash, replace the battery in the receiver collar. If it still does not beep and the test light does not flash visit our website [www.stayfence.ie](http://www.stayfence.ie) for assistance.
11. If the Stayfence receiver collar beeps, there may be a complete or partial break in the boundary wire. See the following page.

## Locating a Break in the Boundary Wire

The easiest way to locate a break in your boundary wire is to make a thorough visual inspection.

- Walk along your boundary wire and check the insulation of the wire. Once the insulation is damaged, water that enters may corrode the wire which may distort the signal.
- Check the tightness of wire when walking along. If it is loose at any place, there might be a break in the wire in that area.
- Check all the splices in the boundary wire for possible corrosion or damages.
- Burying the wire will protect it from damages. But, check your garden for any disturbances near the wire, such as digging or rodent burrowing.

### **Alternative Method Below:**

1. Obtain a length of wire long enough to go from transmitter to a half way point in you boundary.
2. Remove one end of the boundary and connect the new piece to that connection. Bring the new piece to a half way point make a break (or open an existing joint) connect to one end of the now broken boundary. Check to see if you now have a loop indicator light, if not change to the other end of the broken boundary to find which half has the damage.
3. It is advised to check both halves of your boundary wire because there is a possibility that there is more than one break in your wire. Once you have identified the half where the break is located, replace this section boundary wire. (you may also choose to repeat this process) to shorten the replacement length from 50% of the boundary to 25% and so on it is recommended when you decided which 50 % has the break to do another visual inspection .

## Product Safety Information

**The proper fit and placement of your Stayfence Receiver Collar is important for the comfort of your pet and its effective training.**

- (1) Never leave the Stayfence receiver collar on your pet for more than 12 consecutive hours.
- (2) The contact points must be touching the skin. Therefore the collar should be tight on the neck but not over tight (**page 19**).
- (3) You should examine your pet weekly for any signs of irritation.
- (4) If any irritation is observed, discontinue the use of the Stayfence receiver collar for a few days, until any irritation has completely disappeared (pressure point irritation)
- (5) If the condition persists, see your veterinarian.
- (6) Your dog's neck and the probes must be washed weekly with a wash cloth and mild soap and then washed thoroughly.
- (7) Check the fitting of the collar on a dog that's still growing, you need to adjust the collar as much as two times a week.**
- (8) The system should only be used on healthy pets, 6 months and older. Contact your local veterinarian if you have concerns about the medical condition of your pet.
- (9) The Stayfence system is not for vicious or aggressive pets. If your pet may pose a threat to others, **DO NOT USE THIS SYSTEM**. Consult a certified trainer.
- (10) The Stayfence system is for residential use only.
- (11) The static correction is harmless for your pet and is meant to startle, not to punish.
- (12) Test the Stayfence receiver at least once a month to verify that it is functioning properly, at the boundary wire. Battery life depends on how often the Stayfence receiver collar is activated by your pet.
- (13) Remove the Stayfence receiver collar from your pet when indoors, for the comfort of your pet.

## Replacement Parts Available

- (1) CR-2 Battery (for receivers)
- (2) Nylon Collar Straps
- (3) Contact Points - short and long
- (4) Transformer Plugs
- (5) Additional Boundary Wire (bundles of 50)
- (6) Wire Connectors (5 per pack)
- (7) Stayfence Transmitter
- (8) Stayfence Receivers
- (9) Gel Connectors

To purchase any replacement parts please refer to our website.  
[www.stayfence.ie](http://www.stayfence.ie)

